

## User Manual



[www.indesit.com/register](http://www.indesit.com/register)



---

# USER MANUAL

---



## THANK YOU FOR BUYING A INDESIT PRODUCT.

In order to receive a more complete assistance,  
please register your appliance on [www.indesit.com/register](http://www.indesit.com/register)

---

## INDEX

|  |           |
|--|-----------|
| <b>HEALTH &amp; SAFETY GUIDE</b> .....       | <b>3</b>  |
| <b>Safety Instructions</b> .....             | <b>3</b>  |
| <b>USER MANUAL</b> .....                     | <b>5</b>  |
| <b>Product description</b> .....             | <b>5</b>  |
| Detergent dispenser drawer.....              | 5         |
| Technical data for water connection.....     | 5         |
| Control panel.....                           | 6         |
| Wash cycles.....                             | 6         |
| Options.....                                 | 7         |
| Push & Wash.....                             | 8         |
| Functions.....                               | 9         |
| Wash cycle table.....                        | 10        |
| Accessories.....                             | 10        |
| <b>How to use the appliance</b> .....        | <b>11</b> |
| First time use.....                          | 11        |
| Daily use.....                               | 11        |
| Hints and tips.....                          | 12        |
| <b>Cleaning &amp; maintenance</b> .....      | <b>13</b> |
| Disconnect the water and power supplies..... | 13        |
| Clean the washing machine.....               | 13        |
| Cleaning the detergent dispenser drawer..... | 13        |
| Care for the door and drum.....              | 13        |
| Clean the pump.....                          | 13        |
| Check the water inlet hose.....              | 13        |
| <b>Troubleshooting</b> .....                 | <b>14</b> |
| Manual door opening.....                     | 15        |
| Transport and handling.....                  | 15        |
| <b>Service</b> .....                         | <b>16</b> |
| <b>INSTALLATION GUIDE</b> .....              | <b>17</b> |

## SAFETY INSTRUCTIONS

## IMPORTANT TO BE READ AND OBSERVED

Before using the appliance, read these safety instructions. Keep them nearby for future reference. These instructions and the appliance itself provide important safety warnings, to be observed at all times. The manufacturer declines any liability for failure to observe these safety instructions, for inappropriate use of the appliance or incorrect setting of controls.

⚠ Very young children (0-3 years) should be kept away from the appliance. Young children (3-8 years) should be kept away from the appliance unless continuously supervised. Children from 8 years old and above and persons with reduced physical, sensory or mental capabilities or lack of experience and knowledge can use this appliance only if they are supervised or have been given instructions on safe use and understand the hazards involved. Children must not play with the appliance. Cleaning and user maintenance must not be carried out by children without supervision.

Never open the door forcibly or use it as a step.

### PERMITTED USE

⚠ CAUTION: The appliance is not intended to be operated by means of an external switching device, such as a timer, or separate remote controlled system.

⚠ This appliance is intended to be used in household and similar applications such as: staff kitchen areas in shops, offices and other working environments; farm houses; by clients in hotels, motels, bed & breakfast and other residential environments.

⚠ Do not load the machine above the maximum capacity (kg of dry cloth) indicated in the programme table.

⚠ This appliance is not for professional use. Do not use the appliance outdoors.

⚠ Do not use any solvents (e.g. turpentine, benzene), detergents containing solvents, scouring powder, glass or general purpose cleaners, or flammable fluids; do not machine wash fabrics that have been treated with solvents or flammable liquids.

### INSTALLATION

⚠ The appliance must be handled and installed by two or more persons - risk of injury. Use protective gloves to unpack and install - risk of cuts.

If you want to stack a dryer on top of your washing machine, first contact our After-Sales Service or your specialist dealer to verify whether this is possible. This is only possible if the dryer is attached to the washing machine by means of appropriate stacking kit available through our After-Sales Service or your specialist dealer.

⚠ Move the appliance without lifting it by the worktop or top lid.

⚠ Installation, including water supply (if any) and electrical connections and repairs must be carried out by a qualified technician. Do not repair or replace any part of the appliance unless specifically stated in the user manual. Keep children away from the installation site. After unpacking the appliance, make sure that it has not been damaged during transport. In the event of problems, contact the dealer or your nearest After-sales Service. Once installed, packaging waste (plastic, styrofoam parts etc.) must be stored out of reach of children - risk of suffocation. The appliance must be disconnected from the power supply before any installation operation - risk of electric shock. During installation, make sure the appliance does not damage the power cable - risk of fire or electric shock. Only activate the appliance when the installation has been completed.

⚠ Do not install your appliance where it may be exposed to extreme conditions, such as: poor ventilation, temperatures below 5 °C or above 35 °C.

⚠ When installing the appliance make sure that the four feet are stable and resting on the floor, adjusting them as required, and check that the appliance is perfectly to level using a spirit level.

⚠ If the appliance is being installed on wood or "floating" floors (certain parquet and laminate materials), secure a 60 x 60 x 3 cm (at least) sheet of plywood to the floor then place the appliance on top of this.

⚠ Connect the water inlet hose(s) to the water supply in accordance with the regulations of your local water company.

⚠ For cold fill only models: do not connect to the hot water supply.

⚠ For models with hot fill: the hot water inlet temperature must not exceed 60 °C.

⚠ The washing machine is fitted with transport bolts to prevent any possible damage to the interior during transport. Before using the machine, it is imperative that the transport bolts are removed. After their removal, cover the openings with the 4 enclosed plastic caps.

⚠ After installation of the device, wait a few hours before starting it so that it acclimates to the environmental conditions of the room.

⚠ Make sure that the ventilation openings in the base of your washing machine (if available on your model) are not obstructed by a carpet or other material.

⚠ Use only new hoses to connect the appliance to the water supply. The old hose-sets should not be reused.

⚠ The supply water pressure must be in the 01-1 Mpa range.

#### **ELECTRICAL WARNINGS**

⚠ It must be possible to disconnect the appliance from the power supply by unplugging it if plug is accessible, or by a multi-pole switch installed upstream of the socket in accordance with the wiring rules and the appliance must be earthed in conformity with national electrical safety standards.

⚠ Do not use extension leads, multiple sockets or adapters. The electrical components must not be accessible to the user after installation. Do not use the appliance when you are wet or barefoot. Do not operate this appliance if it has a damaged power cable or plug, if it is not working properly, or if it has been damaged or dropped.

⚠ If the supply cord is damaged, it must be replaced with an identical one by the manufacturer, its service agent or similarly qualified persons in order to avoid a hazard - risk of electric shock.

#### **CLEANING AND MAINTENANCE**

⚠ **WARNING:** Ensure that the appliance is switched off and disconnected from the power supply before performing any maintenance operation; never use steam cleaning equipment - risk of electric shock.

#### **DISPOSAL OF PACKAGING MATERIALS**

The packaging material is 100% recyclable and is marked with the recycle symbol .

The various parts of the packaging must therefore be disposed of responsibly and in full compliance with local authority regulations governing waste disposal.

#### **DISPOSAL OF HOUSEHOLD APPLIANCES**

This appliance is manufactured with recyclable or reusable materials. Dispose of it in accordance with local waste disposal regulations. For further information on the treatment, recovery and recycling of household electrical appliances, contact your local authority, the collection service for household waste or the store where you purchased the appliance. This appliance is marked in compliance with European Directive 2012/19/EU, Waste Electrical and Electronic Equipment (WEEE). By ensuring this product is disposed of correctly, you will help prevent negative consequences for the environment and human health.

The symbol  on the product or on the accompanying documentation indicates that it should not be treated as domestic waste but must be taken to an appropriate collection center for the recycling of electrical and electronic equipment.

## PRODUCT DESCRIPTION

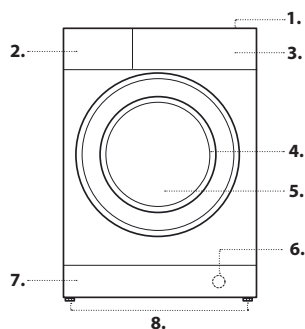

1. Worktop
2. Detergent dispenser
3. Control panel
4. Door handle
5. Door
6. Water filter - behind plinth
7. Plinth (removable)
8. Adjustable feet (4)

## DETERGENT DISPENSER DRAWER

Successful washing results also depend on the correct dose of detergent: adding too much detergent will not necessarily result in a more efficient wash, and may in fact cause build up on the inside of your appliance and contribute to environmental pollution.

! Do not use hand washing detergents because these create too much foam.

! Use powder detergent for white cotton garments, for prewashing, and for washing at temperatures over 60°C.

! Follow the instructions given on the detergent packaging. Open the detergent dispenser drawer and pour in the detergent or washing additive, as follows.

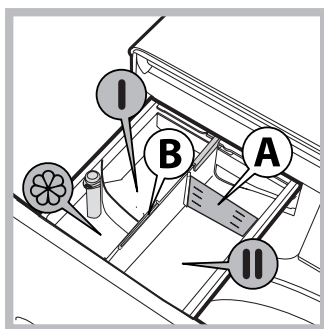

1. Compartment **II**: **Washing detergent (powder or liquid)**
  - If liquid detergent is used, the removable plastic partition **A** (supplied) should be used for proper dosage.
  - If powder detergent is used, insert the partition into slot **B**.
2. Compartment **I**
  - Do not insert detergent in this compartment.
3. Compartment **⊗**: **Additives (fabric softener, etc.)**
  - The fabric softener must never exceed the "max" level indicated on the central pin.

## TECHNICAL DATA FOR WATER CONNECTION

|                                      |                              |
|--------------------------------------|------------------------------|
| <b>Water connection</b>              |                              |
| <b>Water supply</b>                  | Cold                         |
| <b>Water tap</b>                     | 3/4" threaded hose connector |
| <b>Minimum water supply pressure</b> | 100 kPa (1 bar)              |
| <b>Maximum water supply pressure</b> | 1000 kPa (10 bar)            |

## CONTROL PANEL

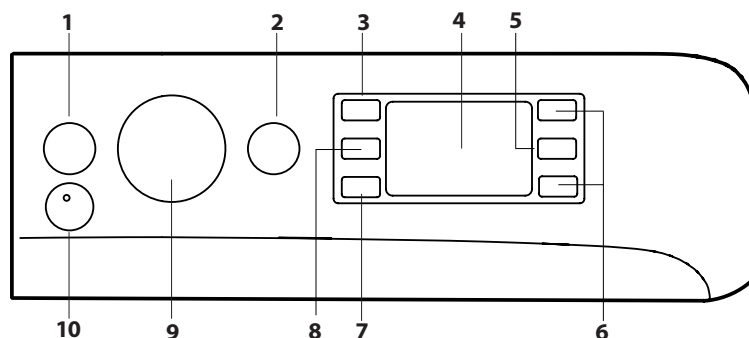

- 1 ON/OFF button
- 2 START/PAUSE button and indicator light
- 3 TEMPERATURE button
- 4 Display
- 5 CHILD LOCK button
- 6 OPTION button
- 7 Delayed Start button
- 8 SPIN button
- 9 WASH CYCLE SELECTOR KNOB
- 10 PUSH & WASH button

## WASH CYCLES

Follow the instructions on the symbols of the garment's wash care label. The value indicated in the symbol is the maximum recommended temperature for washing the garment.

### DAILY COTTON

A 30°C cycle for cotton garments. It allows for reducing electricity consumption for heating the water while guaranteeing good washing performance. Suitable for lightly soiled garments.

### DAILY SYNTHETICS

A 30°C cycle for synthetic garments. It allows for reducing electricity consumption for heating the water while guaranteeing good washing results. Suitable for lightly soiled garments.

### COLOURED

A 30°C cycle that helps to preserve colours, suitable for cotton or synthetic coloured garments. It allows for reducing electricity consumption for heating the water while guaranteeing good washing results. Suitable for lightly soiled garments.

### DELICATES

Suitable for washing very delicate garments. It is advisable to turn the garments inside out before washing them. For best results, use liquid detergent on delicate garments.

### RAPID 30MIN

For washing lightly soiled garments in a short time. Not suitable for wool, silk and garments to be washed by hand.

### COTTON

Suitable for washing towels, underwear, table cloths, etc. made of resistant linen and cotton that are moderately to heavily soiled.

### SYNTHETICS

Suitable for washing moderately soiled garments made of synthetic fibres (e.g. polyester, polyacrylic, viscose, etc.) or mixed synthetic-cotton fibres.

### MIXED

A 40°C cycle for washing cotton and synthetic garments together. Suitable for lightly soiled underwear.

### ECO COTTON

Suitable for washing moderately soiled cotton garments. At 40°C and 60°C it is the standard cycle for washing cotton garments, and is the most efficient in terms of combined water and electricity consumption.

### WHITE COTTON'

For heavily soiled whites and resistant colours.

### RAPID

Allows for varying the garment treatment duration from 20' to 60'.

- **20'**: this cycle refreshes your garments in just 20 minutes.
- **45'**: a short cycle designed for washing mixed cotton-synthetic garments.
- **60'**: this cycle is designed to wash moderately soiled resistant cotton garments at 60°C in an hour, with good washing performance. For synthetic or mixed garments, the temperature should be lowered to 40°C.

**DUVET**

For washing clothing padded with goose down, such as double or single duvets (weighing under 3.5 kg), cushions or down jackets. Duvets should be loaded into the drum with their edges folded inwards and no more than  $\frac{3}{4}$  of the total drum volume should be used up. For best results, it is advisable to use liquid detergent to be poured into the detergent drawer.

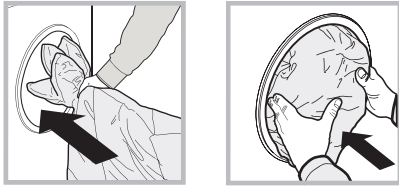
**WOOL - WOOLMARK APPAREL CARE - BLUE:**

The "Wool" wash cycle is approved by the Woolmark Company for washing wool garments classified as "hand-washable", provided that the wash complies with the instructions appearing on the garment's label and with those provided by the manufacturer of this washing machine. (M1127)

**ANTI ODOUR**

Use this cycle (for synthetic fabrics) to wash garments with bad odours (e.g. smoke, sweat, fried food). The cycle is designed to remove bad odours while preserving the fabric fibres.

**RINSE + SPIN**

Designed for rinsing and spinning.

**SPIN + DRAIN**

Designed to spin and drain the water.

**OPTIONS**

! If the selected option is not compatible with the set wash cycle, the indicator light will flash and the option will not be activated.  
! If the selected option is not compatible with another previously selected option, the indicator light will flash accompanied by a buzzer (3 beeps), and only the latter option will be activated; the indicator light corresponding to the activated option will turn on.

 **ANTI-STAIN**

This option allows for selecting the type of dirt so as to optimally adjust the cycle for removing the stains. The following types of dirt can be selected:

 **Food**: for stains caused by foodstuffs and beverages, for example.

 **Work**: for grease and ink stains, for example.

 **Outdoor**: for mud and grass stains, for example.

! The wash cycle duration varies according to the type of selected dirt.

**11**  **RAPID**

When this button is pressed the first time, the 45' icon lights up, when pressed the second time the 60' icon lights up and the third time the 20' icon lights up.

 **DELAYED START**

To set a delayed start for the selected cycle, press the corresponding button repeatedly until the desired delay period has been reached. When this option has been activated, the  symbol lights up on the display. To remove the delayed start setting, press the button until the word "OFF" appears on the display.

 **TEMPERATURE**

Each wash cycle has a pre-defined temperature. To modify the temperature, press the  button. The value will appear on the display.

 **SPIN**



Each wash cycle has a pre-defined spin speed. To modify the spin speed, press the  button. The value will appear on the display.

## PUSH & WASH

This function allows for starting a wash cycle even when the machine is switched off without having to press the ON/OFF  button in advance or, after switching the machine on, without having activated any other button and/or selector knob (otherwise the Push & Wash cycle will be deactivated). To start the Push & Wash cycle press and hold the relative button for 2 seconds. The lit indicator light indicates that the cycle has started. This wash cycle is ideal for cotton or synthetic fabrics, as it washes at a temperature of 30°C and a maximum spin speed of 1,000 rpm. Max load 4 kg (cycle duration 45').

### How does it work?

1. Load the laundry (cotton and/or synthetic garments) and close the door.
2. Pour the detergent and additives.
3. Start the cycle by pressing and holding the Push & Wash button for 2 seconds. The relevant indicator light will turn green and the door will lock (the  symbol lights up).

**N.B.:** starting the wash cycle through the Push & Wash button activates an automatic non-customisable cycle recommended for cotton and synthetic fabrics. This cycle does not allow for setting any additional options. To open the door while an automatic cycle is under way, press the START/PAUSE  button; if the locked door symbol  is off, the door may be opened. Press the START/PAUSE  button again to restart the cycle from the point at which it was interrupted.

4. At the end of the wash cycle the word END will appear on the display.

## FUNCTIONS

### ON/OFF

button: press the button briefly to switch the machine on or off. The START/PAUSE indicator light which flashes slowly in a green colour shows that the machine is switched on. To switch off the washing machine during the wash cycle, press and hold the button for approximately 3 seconds; if the button is pressed briefly or accidentally the machine will not switch off. If the machine is switched off during a wash cycle, this wash cycle will be cancelled.

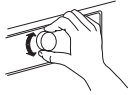





### WASH CYCLE SELECTOR KNOB:

Used to set the desired wash cycle (see "Table of wash cycles").

### START/PAUSE

Button and indicator light: when the green indicator light flashes slowly, press the button to start a wash cycle. Once the cycle has begun the indicator light will remain lit in a fixed manner. To pause the wash cycle, press the button again; the indicator light will flash in an amber colour. If the  symbol is not illuminated, the door may be opened. To start the wash cycle from the point at which it was interrupted, press the button again.

### CHILD LOCK

To activate the control panel lock, press and hold the  button for approximately 2 seconds. The lit  symbol signals that the control panel is locked. This prevents wash cycles from being modified accidentally (except for the ON/OFF  button), especially if there are children in the home. To deactivate the control panel lock, press and hold the  button for approximately 2 seconds.

## DISPLAY

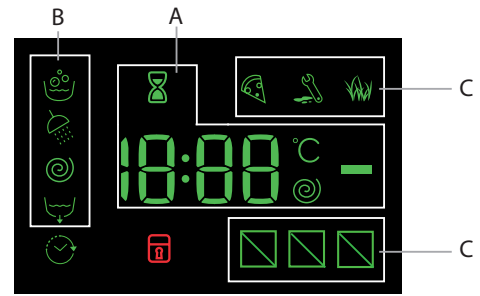



The display is useful when programming the machine and provides a lot of information. The duration of the available wash cycles and the remaining time of a running cycle appear in section **A**; if the Delayed Start option has been set, the countdown to the start of the selected cycle will appear.

Pressing the corresponding button allows for viewing the maximum spin speed and temperature values attained by the machine during the set wash cycle, or the values selected most recently, if these are compatible with the set wash cycle.

The hourglass flashes while the machine processes the data on the basis of the selected cycle. After a maximum of 10 minutes, the  icon remains steady lit and the final time remaining is displayed. The "hourglass" icon will then switch off approximately 1 minute after the final time remaining has been displayed.

The "washing phases" relative to the selected cycle and the "washing phase" of the running cycle appear in section **B**:



-  Wash
-  Rinse
-  Spin
-  Drain

When lit, the "delay" symbol  indicates that the set "Delayed Start" value has appeared on the display.



There are three levels in section **C** relative to the washing options.

### Door locked indicator

When lit, the symbol indicates that the door is locked. To prevent any damage, wait until the symbol turns off before opening the door.

To open the door while a cycle is in progress, press the START/PAUSE button ; if the  symbol is off, the door can be opened.

## WASH CYCLE TABLE

| Maximum load 9 kg<br>Power input in off mode 0.5 W / in left-on mode 8 W           |                  |             |          |                     |                   |                    | Detergents and Additives |                      | Recommended detergent |        | Residual dampness % | Energy consumption kWh | Total water l |
|--|------------------|-------------|----------|---------------------|-------------------|--------------------|--------------------------|----------------------|-----------------------|--------|---------------------|------------------------|---------------|
| Wash cycle   |                  | Temperature |          | Maxim spin (r.p.m.) | Maximum load (kg) | Duration (minutes) | Wash<br>                 | Fabric softener<br>☼ | Powder                | Liquid |                     |                        |               |
|  |                  | Default     | Range    |                     |                   |                    |                          |                      |                       |        |                     |                        |               |
| 1  | Daily cotton     | 30°C        | ☼ - 30°C | 1200                | 4.5               | **                 | ●                        | ○                    | -                     | ✓      | -                   | -                      | -             |
| 2  | Daily synthetics | 30°C        | ☼ - 30°C | 1000                | 4.5               | **                 | ●                        | ○                    | -                     | ✓      | -                   | -                      | -             |
| 3  | Coloureds        | 30°C        | ☼ - 30°C | 1000                | 4.5               | **                 | ●                        | ○                    | -                     | ✓      | -                   | -                      | -             |
| 4  | Delicates        | 30°C        | ☼ - 30°C | 0                   | 1.0               | **                 | ●                        | ○                    | -                     | ✓      | -                   | -                      | -             |
| 5  | Rapid 30min      | 30°C        | ☼ - 30°C | 800                 | 4.5               | 30                 | ●                        | ○                    | -                     | ✓      | 70                  | 0.18                   | 42            |
| 6  | Cotton (2)       | 40°C        | ☼ - 60°C | 1200                | 9.0               | 225                | ●                        | ○                    | ✓                     | ✓      | 53                  | 1.10                   | 97            |
| 7  | Synthetics (3)   | 40°C        | ☼ - 60°C | 1200                | 4.5               | 200                | ●                        | ○                    | ✓                     | ✓      | 32                  | 0.80                   | 78            |
| 8  | Mixed            | 40°C        | ☼ - 40°C | 1200                | 9.0               | **                 | ●                        | ○                    | -                     | ✓      | -                   | -                      | -             |
| 9  | Eco cotton ◻ (1) | 60°C        | 60°C     | 1200                | 9.0               | 250                | ●                        | ○                    | ✓                     | ✓      | 53                  | 1.03                   | 57.5          |
|  |                  |             | 40°C     | 1200                | 9.0               | 225                | ●                        | ○                    | ✓                     | ✓      | 53                  | 1.10                   | 97            |
| 10   | White cotton     | 60°C        | ☼ - 90°C | 1200                | 9.0               | **                 | ●                        | ○                    | ✓                     | ✓      | -                   | -                      | -             |
| 11   | Rapid            | 20°C        | ☼ - 20°C | 800                 | 1.5               | **                 | ●                        | ○                    | -                     | ✓      | -                   | -                      | -             |
| 11   | Rapid            | 40°C        | ☼ - 40°C | 1200                | 4.5               | **                 | ●                        | ○                    | -                     | ✓      | -                   | -                      | -             |
| 11   | Rapid            | 60°C        | ☼ - 60°C | 1000                | 9.0               | **                 | ●                        | ○                    | ✓                     | ✓      | -                   | -                      | -             |
| 12   | Duvet            | 30°C        | ☼ - 30°C | 1000                | 3.5               | **                 | ●                        | ○                    | -                     | ✓      | -                   | -                      | -             |
| 13   | Wool             | 40°C        | ☼ - 40°C | 800                 | 2.0               | **                 | ●                        | ○                    | -                     | ✓      | -                   | -                      | -             |
| 14   | Anti odour       | 40°C        | ☼ - 40°C | 1000                | 3.5               | **                 | ●                        | ○                    | -                     | ✓      | -                   | -                      | -             |
|  | Rinse + Spin     | -           | -        | 1200                | 9.0               | **                 | -                        | ○                    | -                     | -      | -                   | -                      | -             |
|  | Spin + Drain *   | -           | -        | 1200                | 9.0               | **                 | -                        | -                    | -                     | -      | -                   | -                      | -             |

● Required dosage ○ Optional dosage

The cycle duration indicated on the display or instruction manual is an estimate based on standard conditions. The actual duration may vary in relation to several factors, such as the temperature and pressure of the incoming water, ambient temperature, amount of detergent, load quantity and type, load balancing and any additional options selected.

#### Test wash cycle in compliance with regulation 1061/2010:

1) This cycle is designed for normally soiled cotton loads and is the most efficient in terms of both electricity and water consumption; it should be used for garments washable at 60°C or at 40°C. The actual washing temperature may differ from the indicated value.

## ACCESSORIES

Contact our Technical Assistance Service to check whether the following accessories are available for this washing machine model.

#### For all testing institutes:

- 2) Long cotton cycle: set cycle 6 at a temperature of 40°C.
- 3) Long synthetics cycle: set cycle 7 at a temperature of 40°C.

\* By selecting the  cycle and excluding the spin cycle, the washing machine will drain only.

\*\* The duration of the wash cycles can be checked on the display.

#### Stacking kit

With this accessory you can secure the tumble dryer to the upper part of your washing machine to save space and facilitate loading and unloading of the tumble dryer.

# HOW TO USE THE APPLIANCE

## FIRST TIME USE

Once the appliance has been installed, and before it is used for the first time, run a wash cycle with detergent and no laundry, by setting the "Auto-Clean" cycle.

## DAILY USE

### PREPARING THE LAUNDRY



#### Empty the pockets

- Objects such as coins or lighters can damage the washing machine and the drum. Check all buttons.





#### Divide the laundry according to

- Type of fabric (cotton, mixed fibres, synthetics, wool,

garments to be hand-washed). Colour (separate coloured garments from whites, wash new coloured garments separately). Delicates (small garments – such as nylon stockings – and items with hooks – such as bras: insert them in a fabric bag).

### RUNNING A WASH CYCLE









#### Rapid programming



1. Open the door. Load the laundry while making sure not to exceed the maximum load quantity indicated in the cycle table. 
2. Pull out the detergent dispenser drawer and pour the detergent into the relevant compartments as described in "DETERGENT DISPENSER DRAWER" section. 
3. Close the door. 
4. Press the PUSH & WASH button to start the wash cycle. 

7. Select the desired options.



- If the selected option is not compatible with the set wash cycle, the indicator light will flash and the option will not be activated.
- If the selected option is not compatible with another previously selected option, the indicator light will flash accompanied by a buzzer (3 beeps), and only the latter option will be activated; the indicator light corresponding to the activated option will turn on.

#### Traditional programming





1. Press the ON/OFF button ; the START/PAUSE indicator light  will flash slowly green.
2. Open the door. Load the laundry while making sure not to exceed the maximum load quantity indicated in the Wash Cycle Table. 
3. Pull out the detergent dispenser drawer and pour the detergent into the relevant compartments as described in "DETERGENT DISPENSER DRAWER" section. 
4. Close the door. 
5. Use the WASH CYCLE selector knob to select the desired wash cycle: it will be associated with a specific temperature and spin speed that can be modified. The duration of the cycle will appear on the display. 
6. Modify the temperature and/or spin speed: the machine automatically displays the maximum temperature and spin speed values set for the selected cycle, or the most recently-used settings if they are compatible with the selected cycle. Pressing the °C  button gradually reduces the temperature down to the cold wash "OFF" setting. Pressing the  button gradually reduces the spin speed until it is completely excluded ("OFF" setting). Pressing these buttons again restores the maximum values.

8. Press the START/PAUSE  button to start the wash cycle; the relative indicator light will light up steady green and the door will lock ( symbol on).



#### PAUSING A CYCLE

To pause the wash cycle, press the START/PAUSE  button again; the indicator light will flash amber. If the  symbol is not lit, the door may be opened. To start the wash cycle from the point at which it was interrupted, press the START/PAUSE  button again.

#### OPENING THE DOOR, IF NECESSARY



Once a cycle starts, the  symbol turns on to signal that the door cannot be opened. While a wash cycle is running, the door remains locked. To open the door while a cycle is under way, for example, to add or remove garments, press the START/PAUSE  button to pause the cycle; the indicator light will flash amber. If the  symbol is not lit, the door may be opened. Press the START/PAUSE  button again to continue the cycle.

#### CHANGING A RUNNING WASH CYCLE

To change a wash cycle while it is in progress, pause the washing machine using the START/PAUSE  button (the relative indicator light will flash amber), then select the desired cycle and press the START/PAUSE  button again.

! To cancel a cycle that has already begun, press and hold the ON/OFF  button. The cycle will be stopped and the machine will switch off.

**END OF THE CYCLE**

This will be indicated by the word "END" on the display; when the  symbol switches off, the door may be opened. Open the door, unload the laundry and switch off the machine. If you do not press "ON/OFF"  button, the washing machine will switch off automatically after about a half of an hour. Close the water tap, open the door and unload the washing machine. Leave the door ajar to allow the drum to dry.





! If you wish to cancel a cycle which has already begun, press and hold the "ON/OFF"  button. The cycle will be stopped and the machine will switch off.

**HINTS AND TIPS****RULES FOR SEPARATING LAUNDRY**

- Fabric type / indications on label (cotton, mixed fibres, synthetic, wool, handwash items)
- Colour (separate coloured garments from whites, wash new coloured items separately)
- Size (wash items of different sizes in the same load to improve washing efficacy and weight distribution in the drum)
- Delicates (place small items – such as nylon stockings – and garments with clasps – such as braziers – in a laundry bag or in a pillow case with a zip).

**WASH SYMBOLS ON GARMENT LABELS**

The value given in the tub symbol is the maximum temperature possible for washing the garment.

-  Normal mechanical action
-  Reduced mechanical action
-  Much reduced mechanical action
-  Hand wash only
-  Do not wash

**Load balancing system**

Before every spin cycle, to avoid excessive vibrations before every spin and to distribute the load in a uniform manner, the drum rotates continuously at a speed which is slightly greater than the washing rotation speed. If, after several attempts, the load is not balanced correctly, the machine spins at a reduced spin speed. If the load is excessively unbalanced, the washing machine performs the distribution process instead of spinning. To encourage improved load distribution and balance, we recommend small and large garments are mixed in the load.

**CLEAN THE WATER FILTER REGULARLY**

- This is needed to prevent the filter from blocking and preventing the water from draining correctly.

**HOW MUCH DOES YOUR LAUNDRY WEIGH?**

- 1 sheet 400-500 g
- 1 pillow case 150-200 g
- 1 tablecloth 400-500 g
- 1 bathrobe 900-1.200 g
- 1 towel 150-250 g

## CLEANING & MAINTENANCE

**Before performing cleaning and maintenance, switch the washing machine off and disconnect it from the mains power. Do not use flammable liquids to clean the washing machine.**



### DISCONNECT THE WATER AND POWER SUPPLIES

Close the water tap after every wash. This will limit wear on the hydraulic system inside the washing machine and help to prevent leaks.

Unplug the washing machine when cleaning it and during all maintenance work.

### CLEAN THE WASHING MACHINE

The outer parts and rubber components of the appliance can be cleaned using a soft cloth soaked in lukewarm soapy water. Do not use solvents or abrasives.

The washing machine has a "Auto-cleaning" cycle for its internal parts; it must be run without any load in the drum. To optimise this cycle, it is possible to use either detergent (10% of the quantity specified for lightly soiled garments) or special additives to clean the washing machine. We recommend running a cleaning cycle every 40 wash cycles. To start the cycle press buttons  and  simultaneously for 5 seconds.

The cycle will start automatically and will run for about 70 minutes. To stop the cycle, press the START/PAUSE  button.

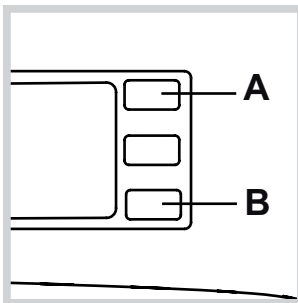

### CLEANING THE DETERGENT DISPENSER DRAWER

To remove the drawer, press lever (1) and pull the drawer outwards (2) (see figure). Wash it under running water; this procedure should be repeated frequently.

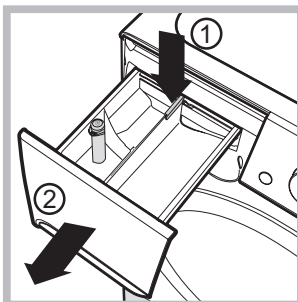

### CARE FOR THE DOOR AND DRUM

Always leave the porthole door ajar in order to prevent unpleasant odours from forming.

### CLEAN THE PUMP

The washing machine is fitted with a auto-cleaning pump that does not require any maintenance. Small items (such as coins or buttons) may sometimes fall into the protective pre-chamber situated at the base of the pump.

**!** Make sure the wash cycle has ended and unplug the appliance.

To access the pre-chamber:

1. Remove the cover panel on the front of the machine by first pressing it in the centre then pushing downwards on both sides to extract it;

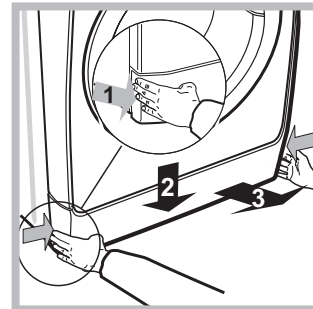

2. Loosen the drainage pump cover by turning it anti-clockwise: it is normal for some water to leak out;

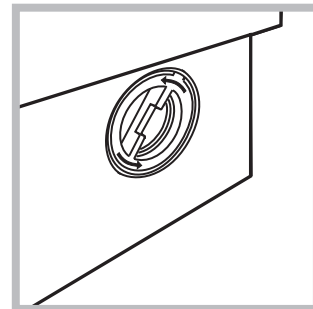

3. Clean the inside thoroughly;
4. Screw the cover back on;
5. Put the panel back in place, making sure the hooks slot in place before pushing the panel onto the appliance.





### CHECK THE WATER INLET HOSE

Check the water inlet hose at least once a year. If it is cracked or broken, it must be replaced: during wash cycles, the high pressure of the water could suddenly split the hose open.

**!** Never use hoses that have already been used.

## TROUBLESHOOTING

The washing machine may occasionally fail to work. Before contacting the Technical Assistance Service, make sure that the problem cannot be easily solved using the following list.

| Anomalies   | Possible causes / Solution  |
|---|---|
| <b>The washing machine does not start.</b>  | The appliance is not plugged into the socket, or not sufficiently to make contact.  |
|   | There is no power in the house.   |
| <b>The wash cycle does not start.</b>   | The washing machine door is not closed properly.  |
|   | The ON/OFF  button has not been pressed.   |
|   | The START/PAUSE  button has not been pressed.  |
|   | The water tap has not been opened.  |
|   | A delay has been set for the start time.  |
| <b>The washing machine does not fill with water ("H2O" flashes on the display).</b>   | The water inlet hose is not connected to the tap.   |
|   | The hose is bent.   |
|   | The water tap has not been opened.  |
|   | There is no water supply in the house.  |
|   | The pressure is too low.  |
| <b>The washing machine continuously loads and unloads water.</b>  | The START/PAUSE  button has not been pressed.  |
|   | The drain hose is not fitted between 65 and 100 cm from the floor.  |
|   | The free end of the hose is immersed in water.  |
|   | The wall drainage system does not have a breather pipe.   |
|   | If the problem persists even after these checks, turn off the water tap, switch the appliance off and contact the Technical Assistance Service. If the home is on one of the upper floors of a building, there may be problems relating to back-siphonage, causing the washing machine to fill with water and drain continuously. Special anti-siphon valves are available in shops and help to prevent this inconvenience. |
| <b>The washing machine does not drain or spin.</b>  | The cycle does not include drainage: with certain cycles it must be started manually.   |
|   | The drain hose is bent.   |
|   | The drainage duct is clogged.   |
| <b>The washing machine vibrates a lot during the spin cycle.</b>  | The drum was not unlocked correctly during installation.  |
|   | The washing machine is not level.   |
|   | The washing machine is tucked between furniture cabinets and the wall.  |
| <b>The washing machine leaks.</b>   | The water inlet hose is not screwed on properly.  |
|   | The detergent dispenser drawer is obstructed.   |
|   | The drain hose is not properly attached.  |
| <b>The "Options" and START/PAUSE  indicator lights flash rapidly and the display visualises an error code (e.g.: F-01, F-...).</b> | Switch off the machine and unplug it, wait for approximately 1 minute and then switch it back on again. If the problem persists, contact the Technical Assistance Service .   |
| <b>There is too much foam.</b>  | The detergent is not suitable for machine washing (it should be marked with "for washing machine use" or "hand wash and machine wash" or similar).  |
|   | Too much detergent was used.  |
| <b>The Push &amp; Wash function does not activate.</b>  | After switching on the machine, a control other than Push & Wash was activated. Switch the machine off and press the Push & Wash button.  |

## TRANSPORT AND HANDLING

**Do not lift the washing machine by gripping it from the upper section.**

1. Unplug the appliance and close the water tap.
2. Check that the door and detergent dispenser drawer are tightly closed.
3. Detach the filling hose from the water tap then detach the drain hose.
4. Empty all the water remaining in the hoses and secure the latter so that they do not get damaged during transport.
5. Apply the transport bolts back on. Repeat, in reverse order, the transport bolt removal procedure described in the "Health & Safety and Installation Guides".

**Important:** Do not transport the washing machine without having fixed the transport bolts.

## SERVICE

### BEFORE CONTACTING THE TECHNICAL ASSISTANCE SERVICE

- Check whether you can solve the problem alone (see "Troubleshooting").
  - Restart the wash cycle to check whether the problem has been solved.
  - If this is not the case, contact an authorised Technical Assistance Centre.
- ! Always request the assistance of authorised technicians.

### CONTACT OUR TECHNICAL ASSISTANCE SERVICE

If after the above checks the fault still occurs, get in touch with the nearest Technical Assistance Service (See phone number in the warranty booklet)

Have the following information to hand:

- the type of problem;
- the appliance model (Mod.);
- the serial number (S/N).

This information can be found on the data plate applied to the rear of the washing machine, and can also be found on the front of the appliance by opening the door.

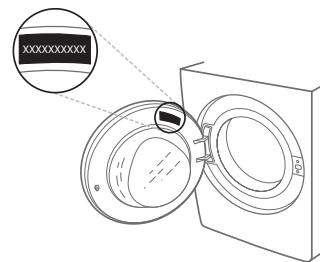

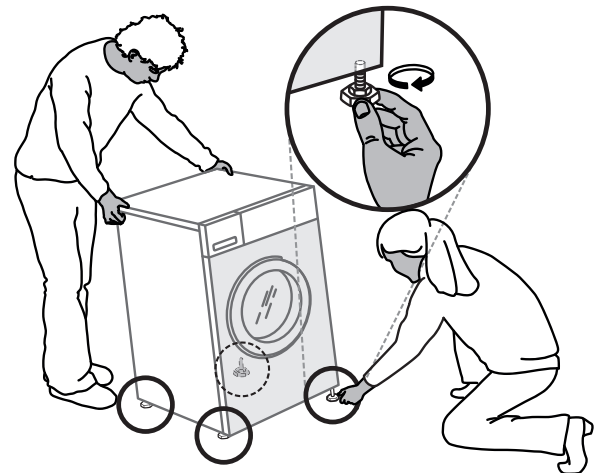
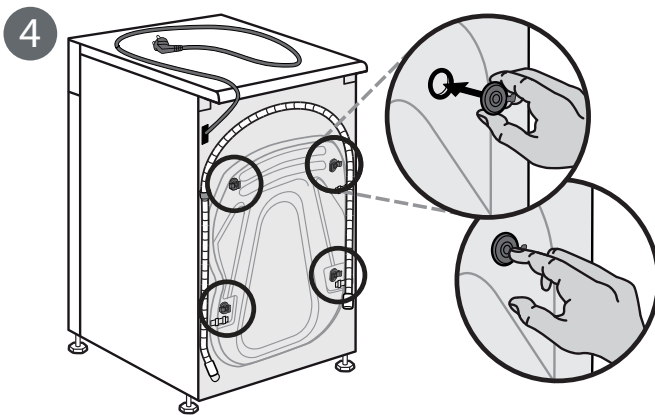
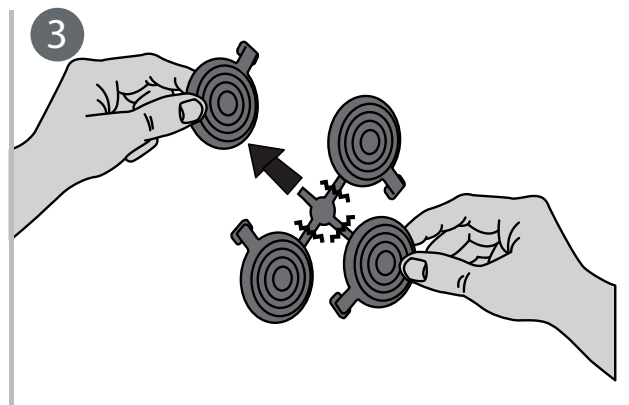
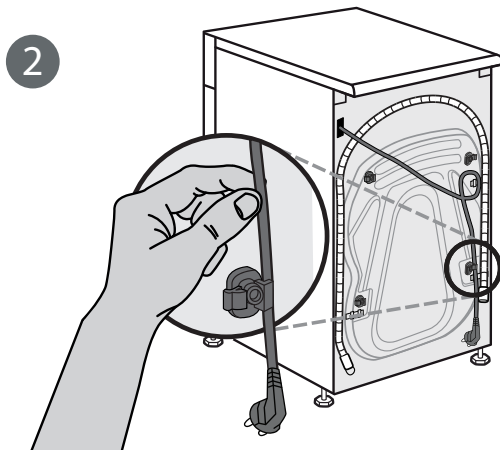
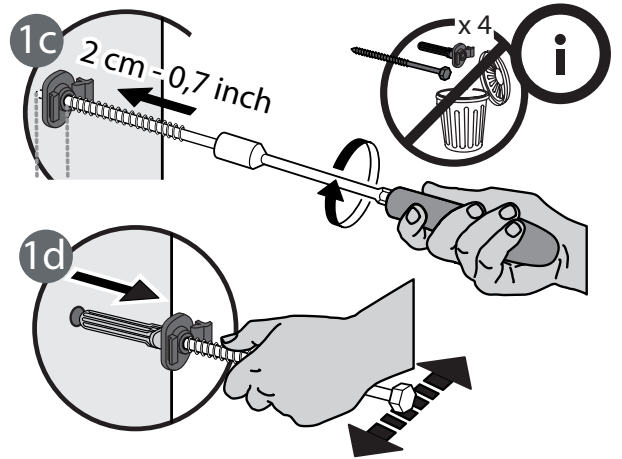
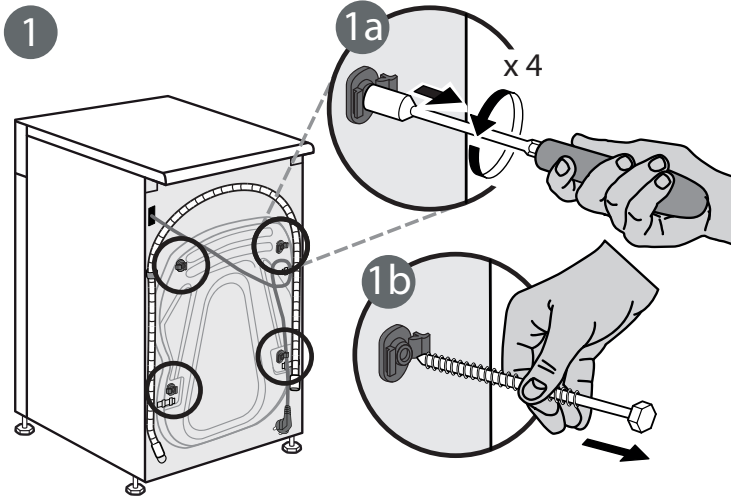
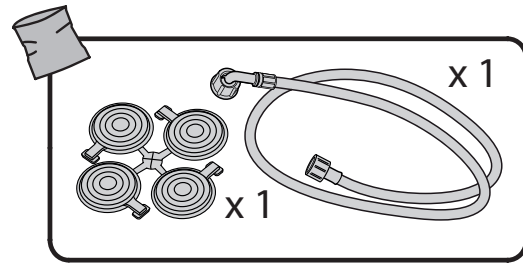
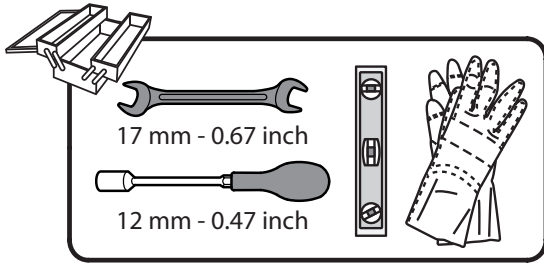

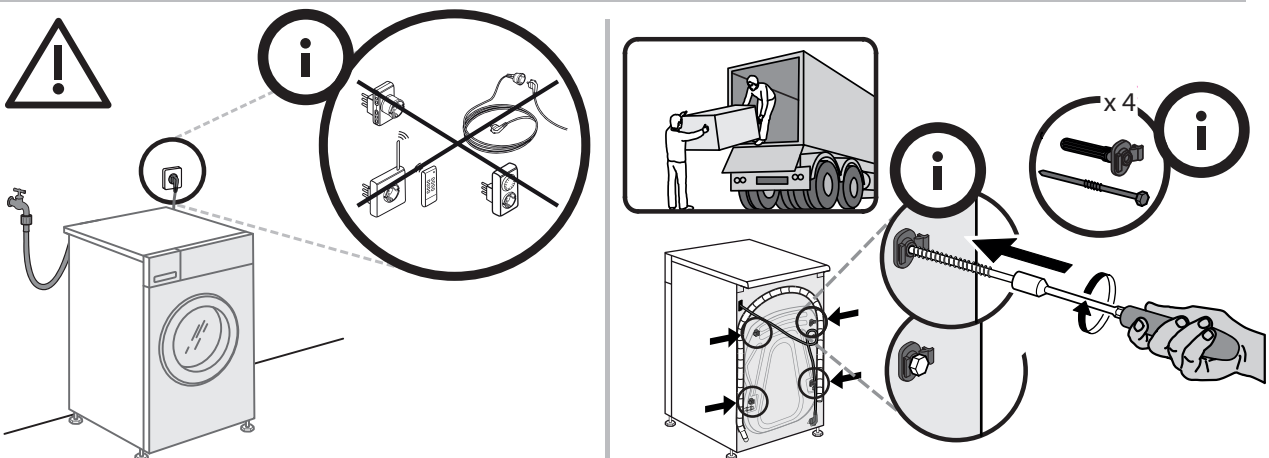
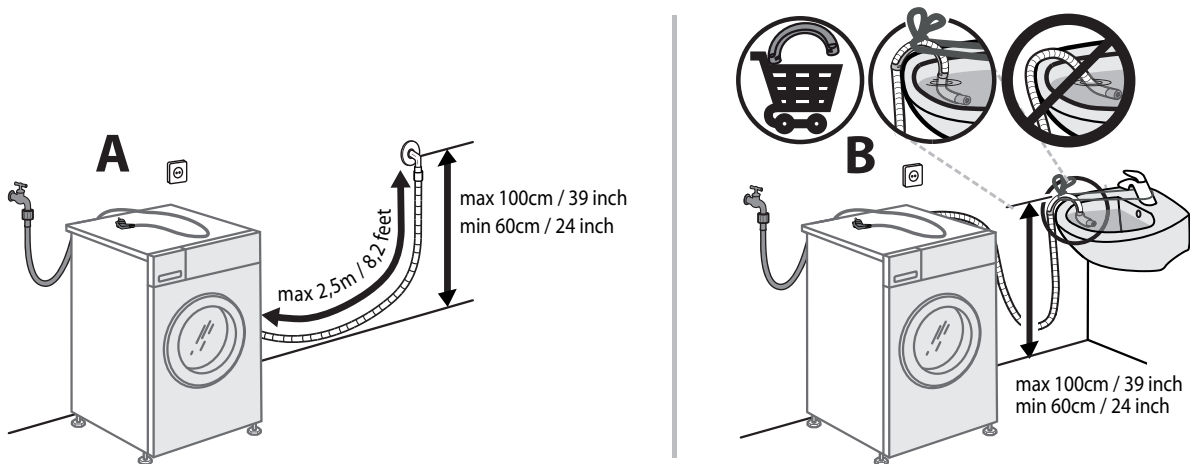
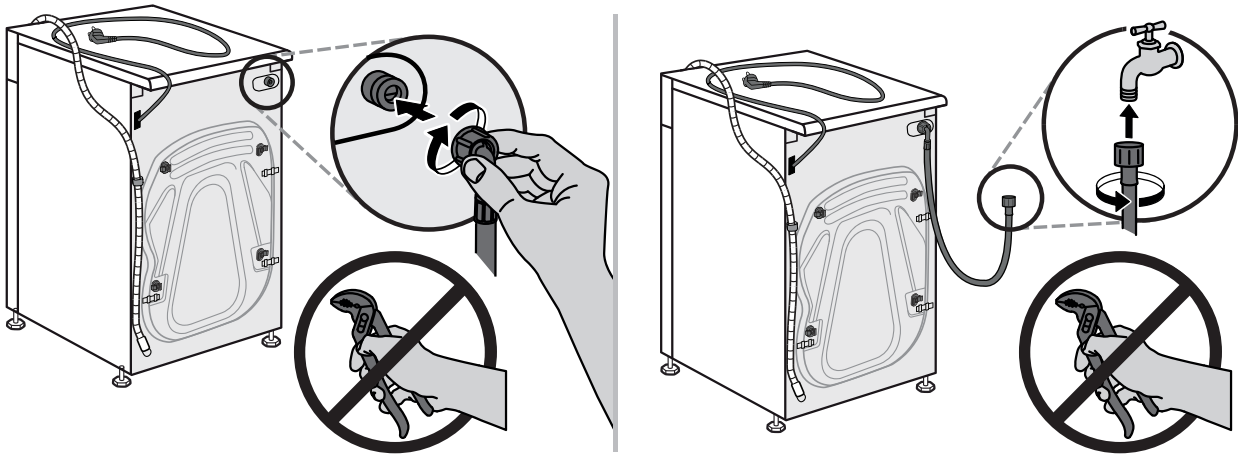
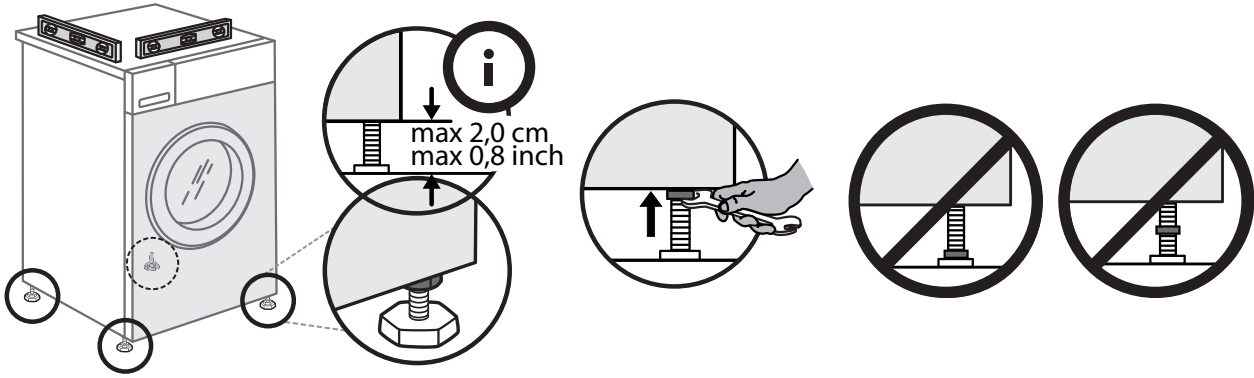

859991536840EN